

# DMS/DMSB

## Agitator Seals



### Product Description

1. Dual seal configuration
2. Balanced design
3. Independent of direction of rotation
4. Cartridge construction
5. Designed for top entry vessels
6. Rotary unit with multiple springs
7. Construction with integrated bearing also available

### Technical Features

1. Available with or without floating Bearing
2. Double Seals Can be applied at higher pressure and rotating Speed
3. Rugged design to ensure long term reliability and operation life
4. Seals are assembled in cartridge construction for easy fitment
5. Over all connecting dimensions are tailor made to customers specification

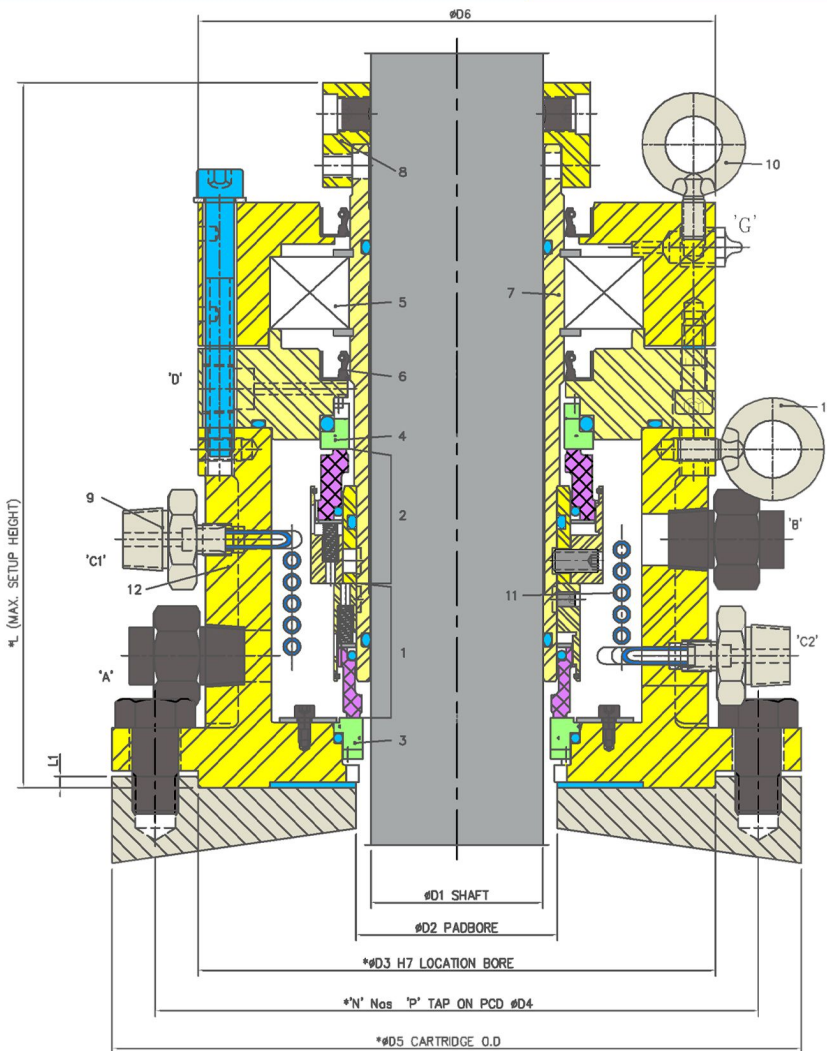

### Industrial Application

Chemical industries  
Pharmaceutical industries

### Material Of Construction

**Seal Face** :Carbon Graphite Antimony Impregnated / Carbon Graphite Resin Impregnated / Silicon Carbide / Glass Filled Teflon  
**Seat**: Carbon Graphite Antimony Impregnated / Carbon Graphite Resin Impregnated / Silicon-Carbide/ Tungsten-Carbide/Ceramic  
**Elastomer**: Viton/Aflas/TTV/EPDM/KALAREZ  
**Metal Parts**: S.S.316 / Hast'C

Note : Other MOC Combinations On Request

### Available Sizes

Sizes: d3 = Upto 160 mm (Upto 6.500")

Note : Other Sizes On Request

### Operating Limits

**Pressure** = Full vacuum to 40 Kg/cm<sup>2</sup> (MAX)

**Temperature** = -25°C to 230°C

**Speed** = up to 300 rpm

### Orientation

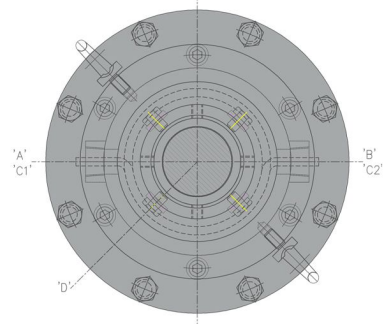

### Connections:

"A & B" Barrier/Buffer Inlet and Outlet  
"C" Grease Port

Item	Description
1,2	Rotary (IB & OB)
3,4	MR(IB&OB)
5	Bearing
6	Oil Seal
7	Sleeve
8	Drive Collar

Item	Description
9	Ferrule Connectors
10	Eye bolt
11	Cooling coil

## Installation, Details, Options

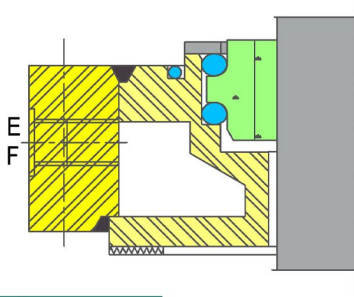

**Option-1**

Heat Trap Arrangement for Higher Temperature Applications

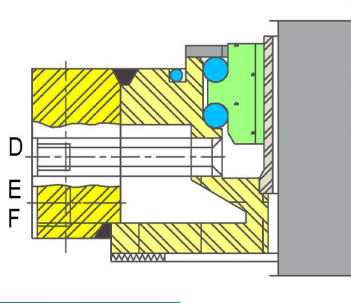

**Option-2**

Heat Trap Arrangement + Debris Collector Can be used for higher Temperature\* for GMP

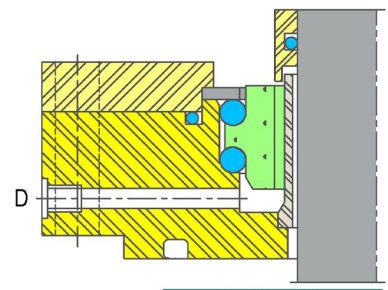

**Option-3**

Debris Collector Unit Can be used for GMP

## Torque Transmissions

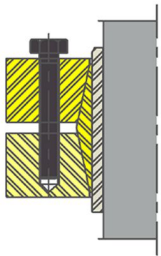

**3-Piece Shrink Disk**

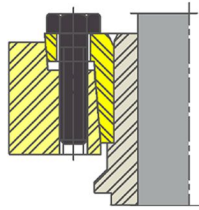

**2-Piece Shrink Disk**

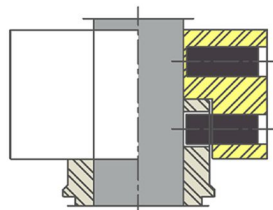

**Double Row Set Screw Drive Collar**

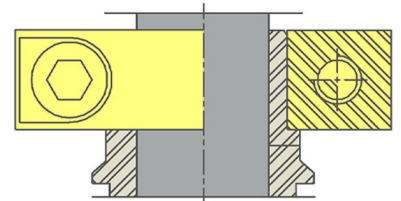

**Split Collar**

## Dimensional Data

							L1	
D1	D2	D3	D4	D5	D6	DMSB	DMS	
20.00	30.00	100.00	126.00	150.00	150.00	228.00	202.00	
30.00	35.00	100.00	136.00	160.00	160.00	228.00	202.00	
40.00	45.00	110.00	165.00	185.00	140.00	214.00	185.00	
50.00	60.00	180.00	200.00	220.00	184.00	270.00	230.00	
60.00	70.00	180.00	210.00	240.00	198.00	270.00	220.00	
70.00	80.00	190.00	220.00	250.00	227.00	280.00	220.00	
80.00	90.00	190.00	240.00	275.00	235.00	300.00	240.00	
90.00	100.00	200.00	255.00	290.00	245.00	290.00	240.00	
100.00	110.00	200.00	265.00	300.00	267.00	315.00	250.00	
110.00	115.00	150.00	275.00	305.00	285.00	320.00	230.00	
120.00	130.00	250.00	295.00	330.00	330.00	293.00	240.00	
130.00	140.00	260.00	310.00	345.00	345.00	320.00	300.00	
150.00	160.00	280.00	350.00	385.00	385.00	350.00	300.00	

Note: Additional technical & dimensional information will be provided on request